

Этап 1

Необходимо досверлить отверстия для крепления ручки, в зависимости от расположения двери (левого/правое)

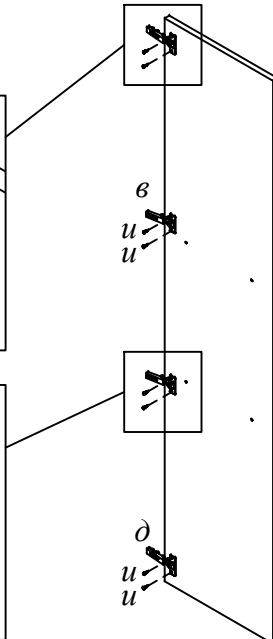

Этап 2

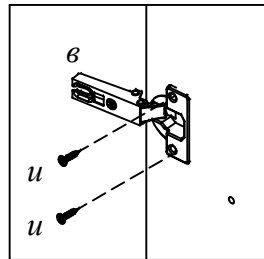
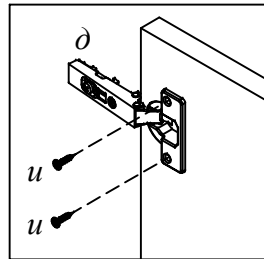

Этап 3

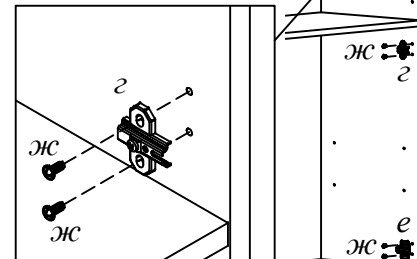
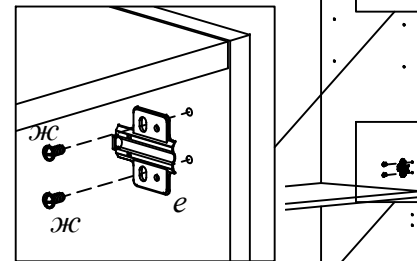

Этап 7

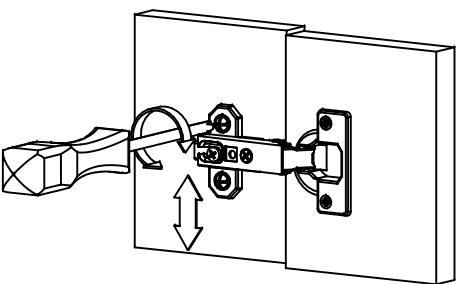
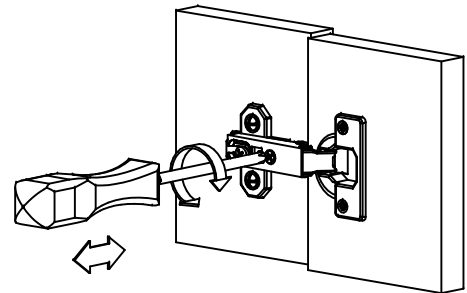
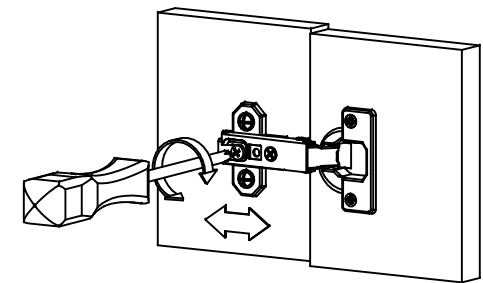

Этап 4

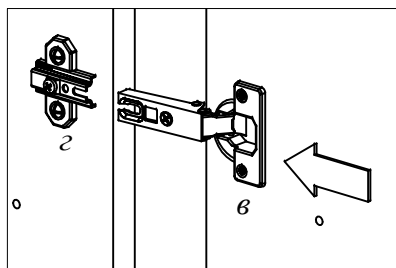
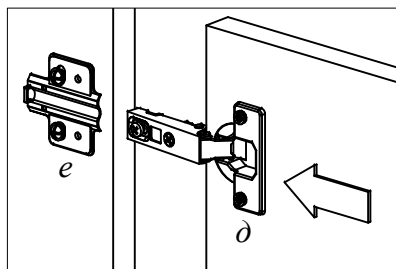

Этап 5

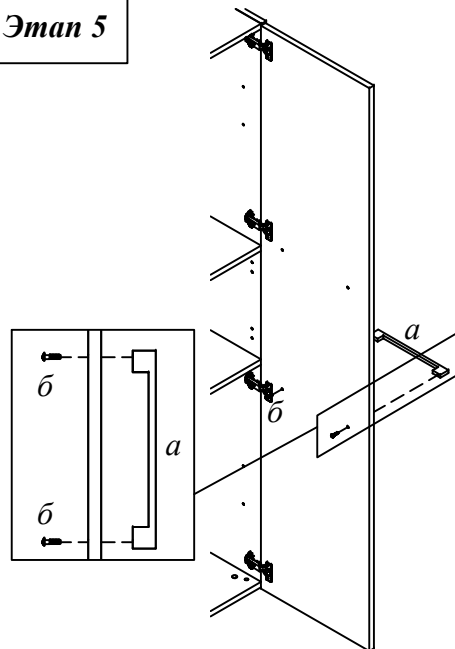

Этап 6

